

※1 -03, -04 BCD出力付きの場合

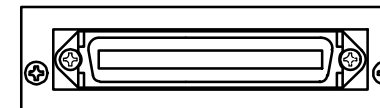

-06 RS-485付きの場合

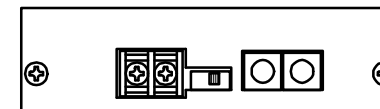

-05 RS-232C付きの場合

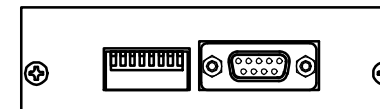

端子ねじ : M3

TSURUGA ELECTRIC CORPORATION. All rights reserved.

REVISED	DATE	Dec. 05, 2008	APPROVED BY		TITLE	3567A
	SCALE		CHECKED BY		デジタルMΩテスタ	
	DESIGNED BY		DRAWN BY		DRAWING No.	FC-01433
	TSURUGA ELECTRIC CORPORATION					

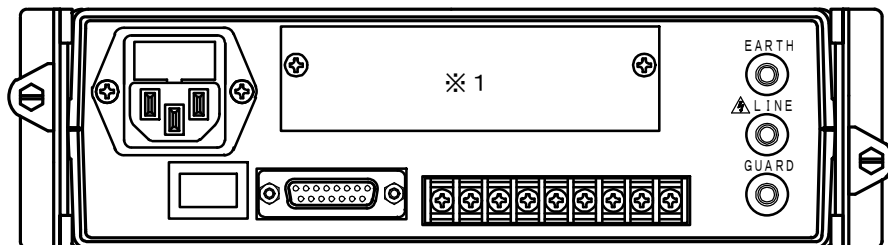
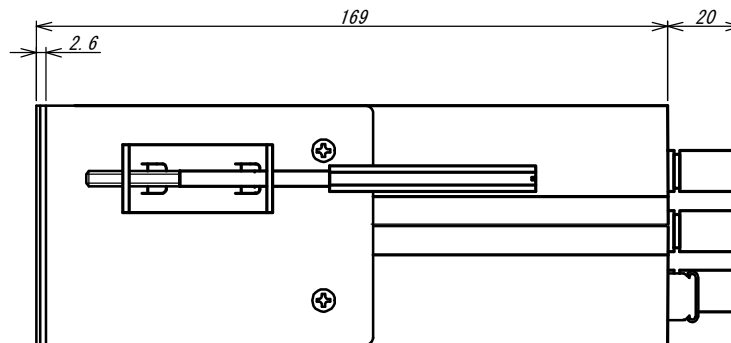
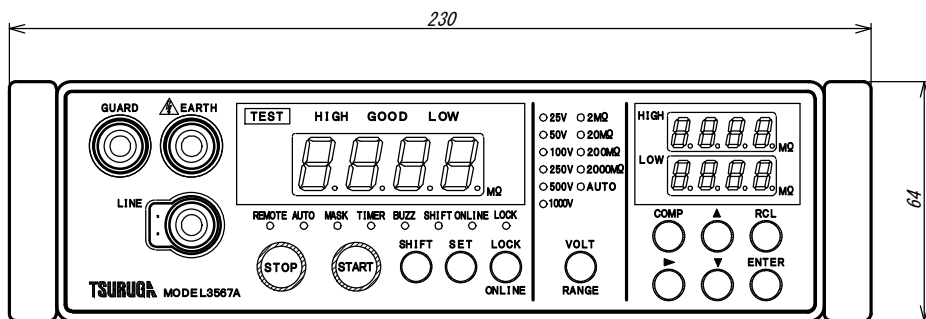

※1 -03, -04 BCD出力付きの場合

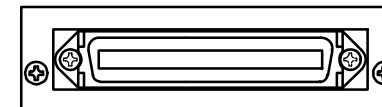

-06 RS-485付きの場合

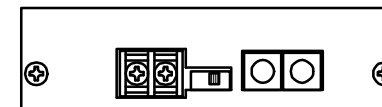

-05 RS-232C付きの場合

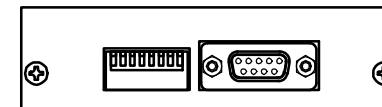

TSURUGA ELECTRIC CORPORATION. All rights reserved.

パネルカット寸法 : 213 ± 0.5 × 65 ± 0.5  
端子ねじ : M3

REVISED	DATE	Dec. 05, 2008	APPROVED BY	TITLE 3567A デジタルMΩテスタ パネルマウントタイプ DRAWING No. FC-01434
	SCALE		CHECKED BY	
	DESIGNED BY		DRAWN BY	
	TSURUGA ELECTRIC CORPORATION			